

MEASURING AND TESTING FACILITIES



BUILDING PHYSICS TESTING	3
MEASURING AND TESTING FACILITIES – AN OVERVIEW	4
HYGROTHERMICS	6

BUILDING PHYSICS TESTING

Fraunhofer IBP is focused on research, development and testing in all fields of building physics. Based on the competence of more than 350 scientists, engineers and technicians numerous outstanding testing resources and measuring instruments are available. Knowledge, experience and creativity can be offered as the keys to innovative products and sustainable quality of buildings. Tailored laboratories and software tools are available in the following departments:



- » **ACOUSTICS**
- » **BUILDING CHEMISTRY,**
- » **BUILDING BIOLOGY, HYGIENE**
- » **ENERGY SYSTEMS**
- » **HEAT TECHNOLOGY,**
- » **LIGHTING TECHNOLOGY**
- » **HYGROTHERMICS**
- » **INDOOR CLIMATE**
- » **LIFE CYCLE ENGINEERING**

We carry out complex building physics studies at our efficient and well-equipped laboratories and test centers and at our outdoor testing site in Holzkirchen, which to the best of our knowledge is the largest facility of its kind. Modern laboratory measuring techniques and computational methods help researchers develop and optimize building products for practical applications. We also carry out experiments in environmental test chambers, simulation facilities and existing buildings to assess components and overall systems for new buildings and renovation projects based on the principles of building physics.

Fraunhofer IBP has been approved by the German building inspection authorities as a testing, monitoring and certification center for building materials and building techniques in Germany and the rest of Europe. Four of the institute's test laboratories have been granted flexible accreditation by the German accreditation body Deutsche Akkreditierungsstelle GmbH (DAkkS) in accordance with DIN EN ISO/IEC 17025. This entitles them to develop new test methods and to modify existing methods.

How to use this digest

The easiest way to find the right laboratory or facility is to use the keyword register, which is organized in three different ways:

-  **Measurements in laboratories** (type of measurement or quantity to be measured)
-  **Measurement objects** (or part of a building etc. to be measured)
-  **Standards** (DIN, EN, ISO, VDI, etc.)

For technical reasons, the departments are listed following the given alphabetical order of the German department names.

MEASURING AND TESTING FACILITIES – AN OVERVIEW

HYGROTHERMICS

Accelerated test to assess the microbial growth resistance of exterior finishes	39
Air-conditioned test hall	36
Air permeability by test facility for impermeability	8
Artificial ageing by combined exposure to radiation, humidity and temperature	26
Calculation of thermal parameters by computer-aided thermal analysis of building components	16
Capillary activity of interior insulation materials	34
Climate simulation in climate chambers and climate cabinets	14
Climate simulation in the big climate simulator	12
Climate simulation in the three-chamber climate simulator	13
Determination of dew water on the surface	38
Drying curve, drying out	31
Durability with driving rain impact	37
Emission coefficient	20
Flexible test facility for flat and pitched roof	40
Heat dissipation of floors	17
Infrared (IR) laboratory	27
Moisture distribution, NMR	33
Moisture storage, sorption	30

Porosity, true density	32
Resistance to wind load by test facility for impermeability	10
Solar Heat Gain Coefficient (SHGC) by calorimeter method	18
Solar simulator for large building components	23
Spectrophotometer	22
Spectroradiometer	25
Tensile strength, e-modulus	35
Test facility for determination of U_g , especially for existing glazings	24
Test facility for solar reflectance index (SRI)	21
Testing machine for mechanical material and component characteristics	19
Thermal conductivity by the guarded hot plate apparatus	7
Thermal conductivity of concentric pipe insulation	15
Thermal resistance and heat transmission coefficient in the Hot Box	11
Water absorption	29
Water tightness against driving rain by test facility for impermeability	9
Water vapor transmission properties	28

MEASUREMENT AND TEST RANGE

HYGROTHERMICS

Contact

Head of Department Dr. Hartwig Künzel | Phone +49 8024 643-245 | hartwig.kuenzel@ibp.fraunhofer.de

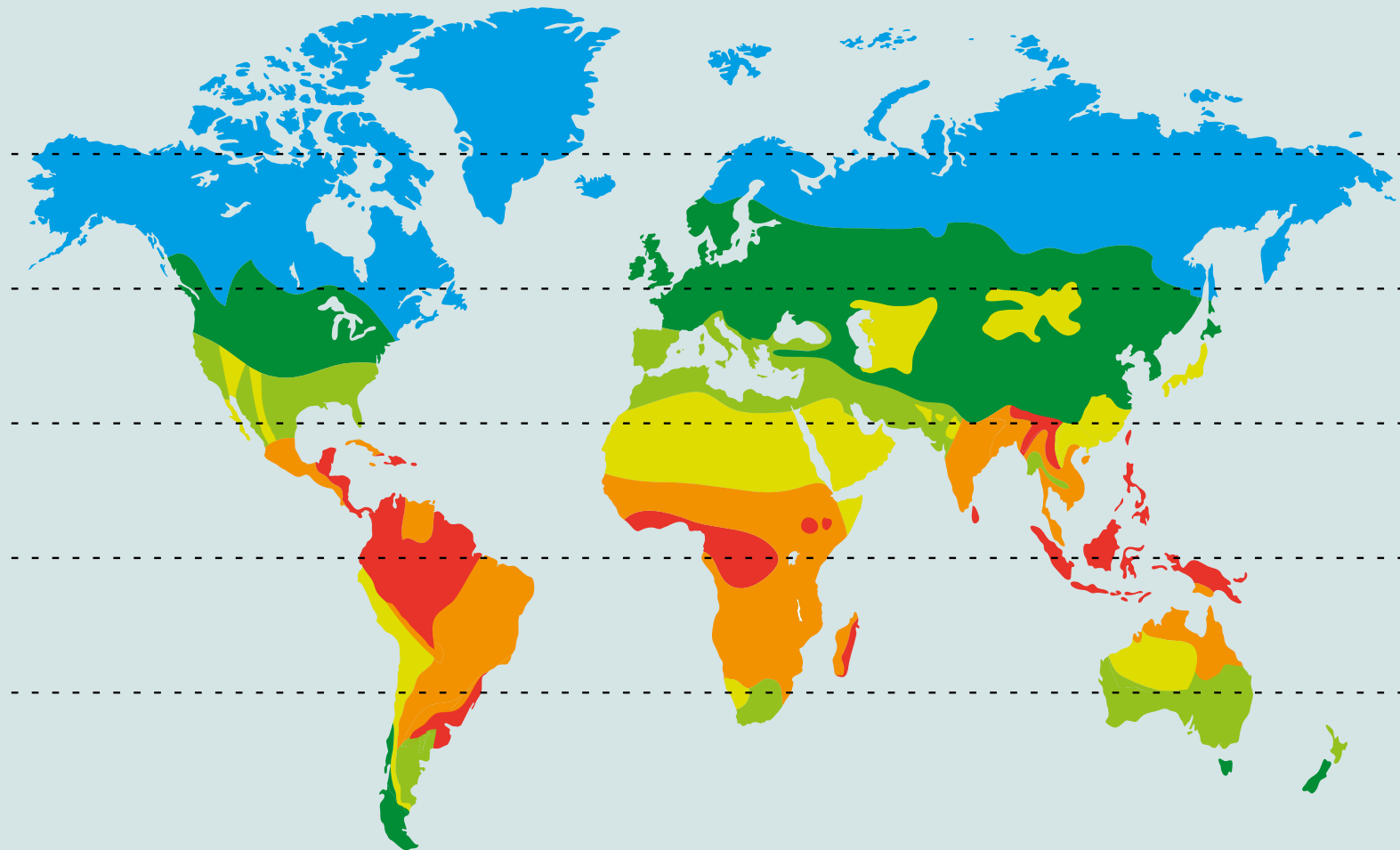

THERMAL CONDUCTIVITY BY THE GUARDED HOT PLATE APPARATUS



Measurement	Thermal conductivity λ , thermal resistance R, and thermal transmittance U
Standards	DIN EN 12664, DIN EN 12667, DIN EN 674, DIN 52612
Measurement object	Homogenous plates, inhomogeneous test specimens: porous, fibrous or granular materials, components laminated, profile plates, glazing elements, sections of building bricks

TECHNICAL DATA

Measuring surface	120 × 120 mm, 150 × 150 mm and 500 × 500 mm
Test specimen dimensions	Square specimens with side lengths between 120 and 900 mm and thicknesses between 5 and 300 mm
Mean specimen temperature	−160 up to +250 °C, depending on the equipment
Measuring range	Thermal conductivity between 0.01 and 2.0 W/(m·K)

SPECIAL FEATURES

Measuring setup	Horizontal and vertical direction
Ambient conditions	Measurements in vacuum or in a protective atmosphere possible

RECOGNITIONS

The test laboratory is recognized by the Deutsches Institut für Bautechnik (DIBt) as a testing facility under applicable building regulations LBO No. BWU10 and as a Notified Body No. 1004 to the terms of the Regulation of Construction Products (EU-BauPVO). It has been granted flexible accreditation under DIN EN ISO/IEC 17025 by the Deutsche Akkreditierungsstelle GmbH (DAkkS) under accreditation No. D-PL-11140-11-04.

AIR PERMEABILITY BY TEST FACILITY FOR IMPERMEABILITY



Measurement	Air permeability
Standards	DIN EN 1026, DIN EN 12207, DIN EN 12427, DIN EN 12426, DIN EN 12153, DIN EN 12152, DIN EN 12114, DIN EN 12835, DIN EN 13141
Measurement object	Windows, doors, gates, curtain walls façades, roof or wall elements (conservatories, glazing elements with integrated sun blinds), foils, adhesive tapes

TECHNICAL DATA

Test specimen dimensions	Height and width up to 4000 mm each, thickness: layers up to 400 mm, roofs up to 8 m length
Measuring range	Air pressure up to 5000 Pa
Air pressure	Static, alternating load (pressure-suction), pulsating
Temperature	-20 up to +70 °C

SPECIAL FEATURES

Specific testing	According to a defined test program
Leakage detection	By means of a fog machine and flow probes

RECOGNITIONS

The test laboratory is recognized by the Deutsches Institut für Bautechnik (DIBt) as a testing facility under applicable building regulations LBO No. BWU10 and as a Notified Body No. 1004 to the terms of the Regulation of Construction Products (EU-BauPVO). It has been granted flexible accreditation under DIN EN ISO/IEC 17025 by the Deutsche Akkreditierungsstelle GmbH (DAkkS) under accreditation No. D-PL-11140-11-04.

WATER TIGHTNESS AGAINST DRIVING RAIN BY TEST FACILITY FOR IMPERMEABILITY



Measurement	Water tightness against driving rain
Standards	DIN EN 1027, DIN EN 12208, DIN EN 12489, DIN EN 12425, DIN EN 12155, DIN EN 12154, DIN EN 12865
Measurement object	Windows, doors, gates, curtain walls façades, roof or wall elements (conservatories, glazing elements with integrated sun blinds), foils, adhesive tapes

TECHNICAL DATA

Test specimen dimensions	Height and width up to 4000 mm each, thickness: layers up to 400 mm, roofs up to 8 m length
Driving rain	e.g., 2L/min/m ² at a simultaneous pressure of more than 1000 Pa
Temperature	-20 up to +70 °C

SPECIAL FEATURE

Specific testing	According to a defined test program: Performance under thermal and hygric load Performance under freeze-thaw cycling
-------------------------	--

RECOGNITIONS

The test laboratory is recognized by the Deutsches Institut für Bautechnik (DIBt) as a testing facility under applicable building regulations LBO No. BWU10 and as a Notified Body No. 1004 to the terms of the Regulation of Construction Products (EU-BauPVO). It has been granted flexible accreditation under DIN EN ISO/IEC 17025 by the Deutsche Akkreditierungsstelle GmbH (DAkkS) under accreditation No. D-PL-11140-11-04.

RESISTANCE TO WIND LOAD BY TEST FACILITY FOR IMPERMEABILITY



Measurement	Resistance to wind load
Standards	DIN EN 12211, DIN EN 1221, DIN EN 12444, DIN EN 12424, DIN EN 12179, DIN EN 13166
Measurement object	Windows, doors, gates, curtain walls façades, roof or wall elements (conservatories, glazing elements with integrated sun blinds), foils, adhesive tapes

TECHNICAL DATA

Test specimen dimensions	Height and width up to 4000 mm each, thickness: layers up to 400 mm, roofs up to 8 m length
Measuring range	Air pressure up to 5000 Pa
Air pressure	Static, alternating load (pressure-suction), pulsating
Temperature	-20 up to +70 °C

SPECIAL FEATURES

Specific testing	According to a defined test program
Leakage detection	By means of a fog machine and flow probes

RECOGNITIONS

The test laboratory is recognized by the Deutsches Institut für Bautechnik (DIBt) as a testing facility under applicable building regulations LBO No. BWU10 and as a Notified Body No. 1004 to the terms of the Regulation of Construction Products (EU-BauPVO). It has been granted flexible accreditation under DIN EN ISO/IEC 17025 by the Deutsche Akkreditierungsstelle GmbH (DAkkS) under accreditation No. D-PL-11140-11-04.

THERMAL RESISTANCE AND THERMAL TRANSMITTANCE IN THE HOT BOX

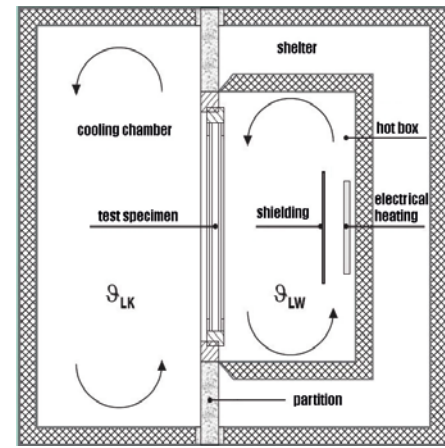

Measurement	Thermal resistance R and thermal transmittance U
Standards	DIN EN ISO 12567-1, DIN EN ISO 12567-2, DIN EN 12412-2, DIN EN 12412-4, DIN EN ISO 8990
Measurement object	Windows (frame and glazing), profiles, skylights, doors, roller shutter casings, roof elements, façade elements, walls

TECHNICAL DATA

Test opening, test specimen dimensions (W × H)	1230 × 1480 mm 1400 × 1600 mm 1100 × 1600 mm 1600 × 2000 mm
Small specimens	From approx. 1.5 m ² , measurements can be conducted by means of masks made of insulating material
Larger specimens	Measurement in the climate simulator

RECOGNITIONS

The test laboratory is recognized by the Deutsches Institut für Bautechnik (DIBt) as a testing facility under applicable building regulations LBO No. BWU10 and as a Notified Body No. 1004 to the terms of the Regulation of Construction Products (EU-BauPVO). It has been granted flexible accreditation under DIN EN ISO/IEC 17025 by the Deutsche Akkreditierungsstelle GmbH (DAkkS) under accreditation No. D-PL-11140-11-04.

CLIMATE SIMULATION IN THE BIG CLIMATE SIMULATOR



Measurement	Protection against heat and against cold, moisture proofing, weather proofing, HVAC analyses, sun simulation, rain simulation, durability testing
Measurement object	Building components, complete building elements, prefabricated house elements, façade elements, walls, ceilings, roof constructions, flat roof systems, design of insulation materials, sandwich constructions, windows, doors, components with thermal bridges, shutter systems, skylights, components for the renovation of building elements, etc.

TECHNICAL DATA

Internal size (L × W × H)	7.0 × 6.0 × 5.8 m
Temperature range	–15 to +55 °C
Humidity range	Dew-point temperature +2 to +27 °C Relative humidity 35 to 85 %

SPECIAL FEATURES

Equipment for temperature control of test specimens	Temperature range –15 up to +55 °C Air circulation 1000 to 6000 m ³ /h
Programmable climate control	Examination of stationary and transient heat and moisture transfer mechanism

MORE INFORMATION

- Door opening (W × H) 2.00 × 3.20 m
- Thermal cycling (without load), cooling rate 15 K/h, heating rate 15 K/h
- Air circulation (laminar or turbulent) 7000 to 30,000 m³/h
- Max. thermal load 76 kW
- Max. point load 20,000 N
- Max. total load 150,000 N

CLIMATE SIMULATION IN THE THREE-CHAMBER CLIMATE SIMULATOR



Measurement	Stationary and transient processes of thermal conductivity and humidity penetration, U-value, storage properties of building components, alternating climate loads, thermal bridges, condensation, cavity convection, vapor diffusion processes, day/night simulation
Measurement object	Large façade and roof elements, prefabricated house elements, door and window elements, thermal insulation by means of external shutters, roller blinds, etc., composite constructions with thermal bridges, multi-layer building components with cavities, charging and discharging cycles of heat storage facilities, equipment for ventilation, heat recovery installations, absorber elements

TECHNICAL DATA

Internal size (L × W × H)	Chamber 1 and 2 2.0 × 4.0 × 2.7 m Chamber 3 2.4 × 4.0 × 2.9 m
Temperature range (chamber 1 and 2/chamber 3)	−30 up to +80 °C
Humidity range (chamber 1 and 2/chamber 3)	Dew-point temperature +2.5 to +58 °C Relative humidity 10 to 95 %

SPECIAL FEATURES

Applications	Up to three simultaneous stationary investigations, programmable alternating climate in each chamber, time lapse investigations, rapid change of temperature
Chambers can be moved	Chamber 1 is stable, chambers 2 and 3 can be moved

MORE INFORMATION

Alternating climate control: (without load), cooling-off rate 50 K/h, heating rate 85 K/h

CLIMATE SIMULATION IN CLIMATE CHAMBERS AND CLIMATE CABINETS



Measurement	Temperature and relative humidity changes, freeze-thaw resistance, durability, aging, air-conditioned storing
Standard	DIN EN 12091
Measurement object	Small-sized building components and building materials, thermal insulating products for building applications

TECHNICAL DATA

Volume of space	Climate chambers approx. 4.6 m ³ and 7 m ³ climate cabinets 0.35 m ³ and 1.50 m ³
Temperature range	Climate chambers +10 to +60 °C climate cabinets –70 to +180 °C
Relative humidity	Climate chambers 20 to 90 % climate cabinets 10 to 98 %

THERMAL CONDUCTIVITY OF CONCENTRIC PIPE INSULATION



Measurement	Thermal conductivity
Standards	DIN EN ISO 8497, EN 14313, EN 14303, EN 14305
Measurement object	Concentric pipe insulation, tubular homogeneous and approximately homogeneous as well as layered test specimens (hollow cylinders, half shells, segments)

TECHNICAL DATA

Measurement section	1.5 m
Test specimen dimensions	Length 3 m, external diameter up to 500 mm
Carrier pipe diameters	From 15 to 87 mm; special dimensions on request
Mean specimen temperature	Within a range of approx. -20 to +90 °C
Measurement range	Smaller than 1 W/m·K

RECOGNITIONS

The test laboratory is recognized by the Deutsches Institut für Bautechnik (DIBt) as a testing facility under applicable building regulations LBO No. BWU10 and as a Notified Body No. 1004 to the terms of the Regulation of Construction Products (EU-BauPVO). It has been granted flexible accreditation under DIN EN ISO/IEC 17025 by the Deutsche Akkreditierungsstelle GmbH (DAkkS) under accreditation No. D-PL-11140-11-04.

MORE INFORMATION

- Determination of energy savings, prevention of condensation, corrosion protection, service temperature, values for CE marking
- Pipe insulation, e.g., made of PE cellular plastics, PIR rigid foam, mineral wool, PU cellular plastics, foam glass, vinyl rubber, PS rigid foam in hoses, half shells, wound strands

CALCULATION OF THERMAL PARAMETERS BY COMPUTER-AIDED THERMAL ANALYSIS OF BUILDING COMPONENTS



Measurement	Thermal transmittance U, linear thermal transmittance ψ , thermal resistance R, equivalent thermal conductivities, temperatures and temperature gradients, dew-point temperatures, heat flow and heat flow densities
Standards	DIN EN ISO 10211, DIN EN ISO 10077
Measurement object	Window profiles, frame profiles, glass edge bond, spacers of laminated insulation glazing units, shutter boxes, masonry units, masonry, roof and façade elements with thermal bridges, cavities, fixing elements

TECHNICAL DATA

Calculation program	STATWL, PHYSIBEL
Data of specimens	Completely dimensioned drawings, e.g., CAD drawing in DXF format, material properties (thermal conductivity, transient also density ρ , specific heat capacity c_p),

SPECIAL FEATURES

Variety of calculation	Transient and stationary temperature, two- and three-dimensional,
Presentation	Parameters, graphic presentation of the results

RECOGNITIONS

The test laboratory is recognized by the Deutsches Institut für Bautechnik (DIBt) as a testing facility under applicable building regulations LBO No. BWU10 and as a Notified Body No. 1004 to the terms of the Regulation of Construction Products (EU-BauPVO). It has been granted flexible accreditation under DIN EN ISO/IEC 17025 by the Deutsche Akkreditierungsstelle GmbH (DAkkS) under accreditation No. D-PL-11140-11-04.

HEAT DISSIPATION OF FLOORS

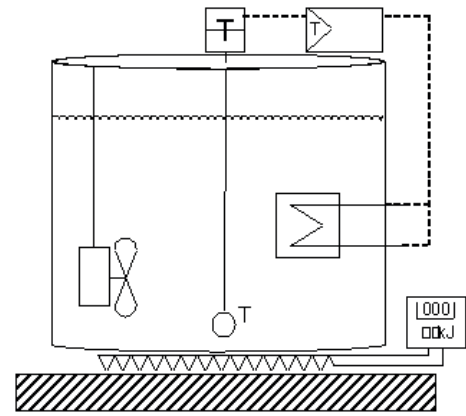

Measurement	Heat dissipation of floors
Standard	DIN 52614 (withdrawn)
Measurement object	Homogeneous and approximately homogeneous as well as layered floor structures and coverings such as PVC, cork, parquet, linoleum, textile fibers, tiles, industrial floor coverings, polyester resin sheets, etc.

TECHNICAL DATA

Test specimen dimensions	500 × 500 mm
---------------------------------	--------------

MORE INFORMATION

- Even as the standard is withdrawn, this measuring method is still used because of the significance of the results
- Heat dissipation levels from “not sufficiently warm to the feet” (level I) over “sufficiently warm to the feet” (level II) up to “particularly warm to the feet” (level III)

SOLAR HEAT GAIN COEFFICIENT (SHGC) BY CALORIMETER METHOD

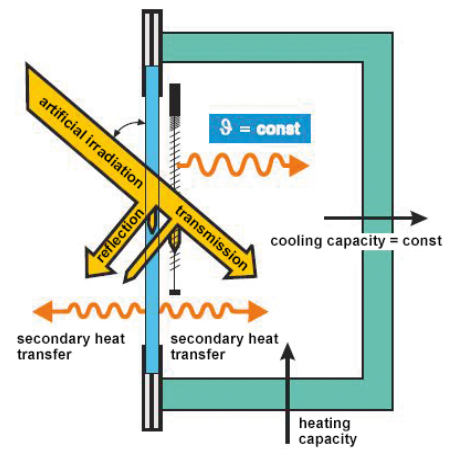

Measurement	Solar heat gain coefficient (SHGC), g-value
Standards	In addition to DIN EN 410 and DIN EN 13363-2
Measurement object	Glazings with shading systems or with more than 3 panes, high-scattering glazing, special components with integrated sun protection, domed building components (domed roof lights, membrane constructions), transparent specimens, vehicle constructions, screen printing or three-dimensional fabrics

TECHNICAL DATA

Standard size and area of aperture	1 m ² , minimum of 0.5 m ²
Test specimen dimensions	Minimum edge length 0.6 m, maximum of 2.9 m depending on construction

SPECIAL FEATURE

Test method	<p>Nondestructive test method on special components, which are not included in above mentioned standards. This method is according to the latest state of technology but no normative standard yet.</p> <p>The specimen is exposed to artificial solar radiation in the range 300 to 900 W/m². Then an energy balance is performed for the Hot Box behind the sample for defined environmental conditions.</p>
--------------------	---

MORE INFORMATION

Additional method for above mentioned standards if optical parameters, gas fill rates or emission coefficients are missing or not available. A common application is the determination of g-values for glazings in existing buildings or for the acceptance of construction.

TESTING MACHINE FOR MECHANICAL MATERIAL AND COMPONENT CHARACTERISTICS

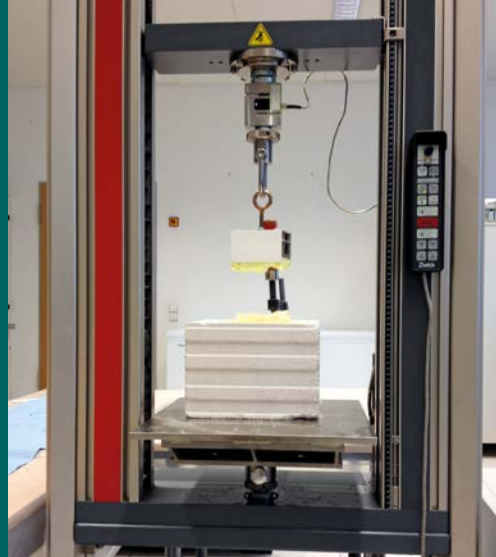

Measurement	Compressive stress, bending stress, tension/e-modulus, cyclic loading, nail tensile test, T-peel test, shear strength, bond strength
Standards	DIN EN 826, DIN EN 13163, DIN EN 12310-1, DIN EN ISO 11339
Measurement object	Insulation materials, textiles, plastics, building materials, concrete samples, adhesions, air-tightness-layers, roof underlays

TECHNICAL DATA

Maximum loads (compressive stress/tension)	a) 20 kN (compressive stress, shearing, bending, tension) b) 400 kN (compressive stress)
Max. size of test samples	Compressive stress a) 300 × 300 mm b) 420 × 520 mm Bending stress 350 × 450 mm Tension test 500 × 80 × 10 mm
Max. lift	a) 900 mm b) 50 mm
Temperature	Standard: room temperature. Pre-tempering of the specimen between -40 to +300 °C possible

SPECIAL FEATURE

Universal usage	Force or distance controlled load types possible, a number of standard test methods are via database quickly available, custom test methods possible, generation of dynamic loads
------------------------	---

RECOGNITIONS

The test laboratory is recognized by the Deutsches Institut für Bautechnik (DIBt) as a testing facility under applicable building regulations LBO No. BWU10 and as a Notified Body No. 1004 to the terms of the Regulation of Construction Products (EU-BauPVO). It has been granted flexible accreditation under DIN EN ISO/IEC 17025 by the Deutsche Akkreditierungsstelle GmbH (DAkkS) under accreditation No. D-PL-11140-11-04.

EMISSION COEFFICIENT

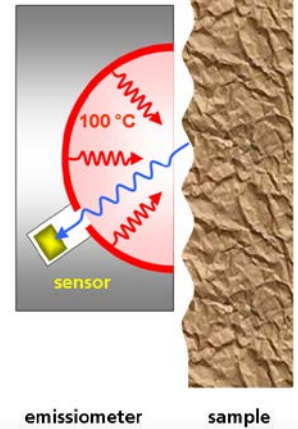

Measurement	Thermal emission coefficient and reflection coefficient
Standards	DIN EN 16012 (attachment D), alternative method for DIN EN 12898 and DIN EN 673
Measurement object	Glass including functional layers, insulation materials, roofing underlays or coverings, building panels, façades, floor coverings, concrete, asphalt, IR-reflecting films and almost all surfaces and structures with roughness up to 10 mm, opaque to IR radiation, varnishes and paints on substrate

TECHNICAL DATA

Spectral range	2.5 to 40 μm
Measurement range	0.02 to 0.99 %
Test specimen dimensions	Optional, minimum size 100 × 100 mm

SPECIAL FEATURE

Scope of application	Nondestructive method, investigation of already existing building products, quality control during production
-----------------------------	---

MORE INFORMATION

- Surfaces preferably mounted in vertical position ($\pm 30^\circ$)
- In-situ measurements under appropriate conditions possible

TEST FACILITY FOR SOLAR REFLECTANCE INDEX (SRI)



Measurement	Solar Reflectance Index (SRI), warming potential under high irradiation
Standards	ASTM E 1980, further procedures ASTM E 1918, ASTM E 903, DIN EN 410, LEED rating
Measurement object	Roofing, tiles, façade sheeting, varnishes and paints, precast concrete parts, asphalt, pavers, parking area, streets, terrace slabs as well as other thin layers of building material layers, which are used in façades, roofs or other parts of building envelope or traffic areas

TECHNICAL DATA

Boundary conditions	1000 W/m ² , T _{amb} = 37 °C h _c = 5, 12, 30 W/(m ² K)
Measurement range	SRI 0 to 100
Input characteristics	Solar reflectance and thermal emissivity
Size of test samples	Any type as long as minimum size within 100 × 100 mm for closed surfaces, minimum size of 16 m ² for bulk materials are considered.

SPECIAL FEATURES

Universal usage	Nondestructive method to determine the warming potential of building surfaces, investigations for existing constructions possible, with a variety of auxiliary methods it can also be used on surfaces with structure and for bulk materials, e.g., gravel on roofs
Method	Relative procedure for the determination of the warming potential of a surface in comparison with a black and a white surface

MORE INFORMATION

In-situ measurements available under appropriate conditions

SPECTROPHOTOMETER

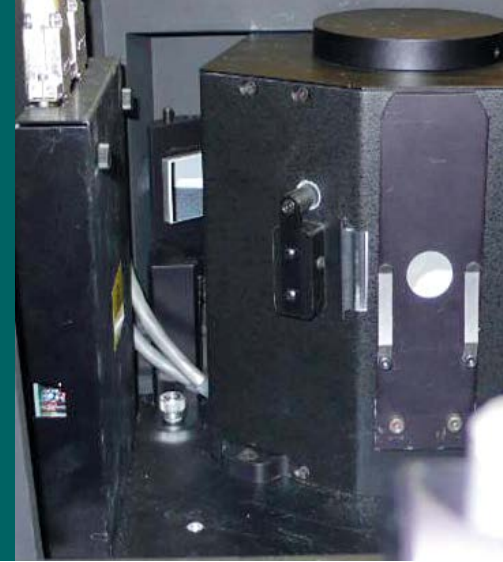

Measurement	Absorbance, transmittance and reflectance (UV/VIS/NIR), radiation and optical technical parameters preferably in the solar spectrum
Standards	DIN EN 410, ASTM E 903, DIN EN 13363-2
Measurement object	Organic and mineral glasses, functional layers, varnishes and paints, plastics, concrete, wood-based materials, building boards, metal sheets, light-directing building components and other transparent, translucent or opaque building materials

TECHNICAL DATA

Measurement range	185 to 3300 nm
Resolution	UV/VIS < 0.05 nm, NIR < 0.2 nm
Integrating sphere	150 mm diameter
Size of test samples (W x B x L)	Preferably 50 x 50 x < 10 mm For reflection measurements special sizes up to 0.5 m ² and thicknesses up to 100 mm possible

SPECIAL FEATURES

- Testing facility for determination of optical input parameters for calculation methods as DIN EN 410 and DIN EN 13363-2
- Nondestructive laboratory procedure, short measuring time, high reproducibility

MORE INFORMATION

A combination of Tungsten and Deuterium light sources enables a big variety of the measuring range.

SOLAR SIMULATOR FOR LARGE BUILDING COMPONENTS



Measurement	Thermal load tests, spontaneous failure, temperature of building components, g-value (SHGC/total energy transmittance), fitness for purpose, aging behavior, thermal expansion, fogging of closed glass façades
Standards	Alternative method to DIN EN 410, DIN EN 13363-2, DIN EN 4892
Measurement object	Façades and roof components with opaque, translucent or transparent partial areas, transparent building components with light-directing elements, sun protection or shading facilities, also in interspace between the panes, glazing with integrated photovoltaics

TECHNICAL DATA

Irradiated area	1 to 8 m ²
Effective irradiance	500 to 1200 W/m ²
Sun elevation angle	0 to 90°
Quality of radiation	Solar-near spectrum, mainly parallel beams, variable diffuse component up to 100 % possible
Installation of the specimens	Wall to roof (0 to 90° continuously)

SPECIAL FEATURES

- The solar simulator reproduces almost all global radiation loads on building components in their original size and original mounting position. Smaller specimen can be irradiated with higher intensity, e.g., aviation
- Weather-independent test facility with reproducible boundary conditions

MORE INFORMATION

For long-term weathering testing and thermal load tests additional solar simulation facilities for sizes between 180 × 260 mm and 4 m² are available.

TEST FACILITY FOR DETERMINATION OF U_g ESPECIALLY FOR EXISTING GLAZINGS

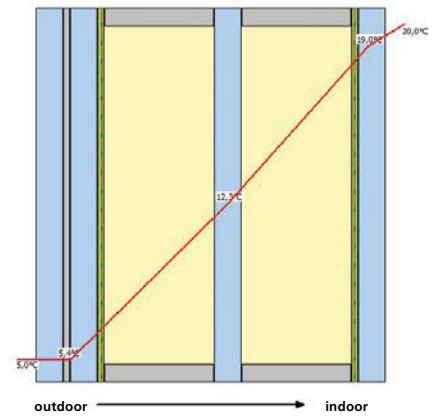

Measurement	U_g according to DIN EN 673 (thermal transmittance coefficient), based on analysis of filling gas or residual oxygen, thermal emissivity, construction of glazing
Standard	DIN EN 673 (alternative procedure to DIN EN 674, DIN EN 675)
Measurement object	multiple glazing with 2 to 5 individual panes, thermal insulation glazing, solar control glazing, post-control of already existing glazings

TECHNICAL DATA

Test specimen dimensions	Any dimensions
Analysis of filling gas	Determination of air, argon and krypton in the gap between the panes (0 to 100 %) by means of analysis of residual oxygen and thermal conductivity detector
Emissivity	0.02 to 0.99 %
U_g	0.3 to 3.0 W/(m ² K)

SPECIAL FEATURES

Special dimensions	This procedure is particularly suitable for glazings, which doesn't comply to standard parameters of measuring in the Hot Plate Apparatus or Hot Box
Installation	Due to the combination of calculation and measuring, the real mounting position can be considered by the calculation
Acceptance testing	Verification of the actual glazing quality during acceptance of construction

MORE INFORMATION

Besides the analysis of filling gas, a filling operation with noble gases for multiple glazing is also available. Any gas filling rates can be performed, e.g., for additional examinations of prototypes.

SPECTRORADIOMETER

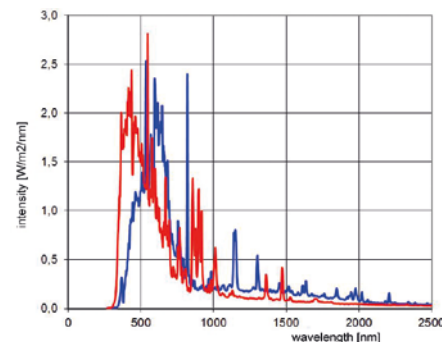

Measurement	Spectrum of emitted radiation from light sources, transmission, absorption and reflection, evaluation of solar simulation equipment, spectral analysis of daylight, integral and wavelength-dependent irradiance
Standards	Additional/special procedure for DIN EN 410, generation of spectral match reports for measuring class, performance as per IEC 60904, ASTM E 927, colorimetry CIE 1931 and CIE 1964
Measurement object	Light sources of any type, solar simulation facilities, glazing façades, roof and wall building components

TECHNICAL DATA

Test specimen dimensions	Any dimensions
Integration time	5 to 10 s
Resolution	Wavelength-dependent 1 to 10 nm
Viewing angle	150°
Installation of the specimens	Wall to roof (0 to 90° continuously variable)

SPECIAL FEATURES

Building dimensions	Due to the compact size, the spectroradiometer is portable and can be used locally during customer visits. A 3 m long glass fibre disconnects the sensor head from the spectrometer. Therefore measurement is independent on location and can be operated in narrow spaces.
Temperature range	Sensor head -30 to +70 °C, noncondensing
Intensity of irradiation	Integration can be done very fast on a wide variety of bandwidths within the measurement range
Calibration	Traceable to NIST

ARTIFICIAL AGEING BY COMBINED EXPOSURE TO RADIATION, HUMIDITY AND TEMPERATURE

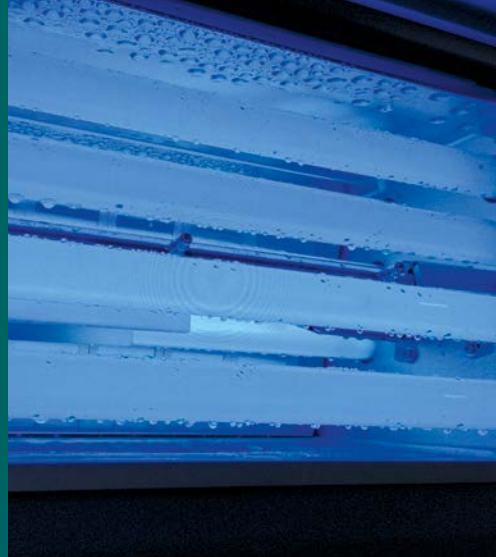

Measurement	Change of material and component properties, e.g. strength, hardness, embrittlement, chalking, fading, transmittance, emissivity, yellowing, geometry
Standards	DIN EN 927-6, DIN EN 1297, DIN EN 1898, DIN EN 12224, DIN EN 12543-4, DIN EN 13523-10, DIN EN 75220, DIN EN ISO 4892-1, DIN EN ISO 4892-2, DIN EN ISO 4892-3, DIN EN ISO 11507, DIN EN ISO 11895, DIN EN ISO 11997-2, ASTM D 3424, ASTM D 4329, ASTM D 4587, ASTM D 4799, ASTM D 5071, ASTM D 5208, ASTM D 6695, ASTM G 151, ASTM G 154, ASTM G 155, SAE J 2020, prEN 1062-4
Measurement object	Organic glasses, films, coatings, paints, plastics, gaskets, sealants, roof linings, bitumen and elastomer roofing sheets, vehicle and façade components

TECHNICAL DATA OF INDIVIDUAL SPECTRAL RANGES

UV-A (fluorescent tubes)	Spectral range	300 to 400 nm, max. 340 nm
	Irradiation	0.35 to 1.65 W/m ² at +35 to +80 °C
	Humidity (cyclic)	condensing or spraying
	Sample size	76 × 152 mm (48 pieces) to 488 × 311 × 25 mm (4 pieces)
Solar, Device A (Xenon lamps)	Spectral range	300 to 800 nm
	Irradiation	250 to 765 W/m ² at +35 to +100 °C
	Humidity	cyclic underwater storage
	Max. sample size	190 × 280 mm
Solar, Device B (metal halide lamps)	Spectral range	280 to 3000 nm
	Irradiation	800 to 1200 W/m ² at –40 to +120 °C
	Humidity	rel. humidity 20 to 80 %
	Max. sample size	900 × 1500 mm, height by arrangement

SPECIAL FEATURES

Reduced testing periods	By reducing or omitting dark phases and consistently high irradiances typical load durations are 1 to 8 weeks. The testing periods are thus shorter than in outdoor exposure.
Reproducibility	Reduced number of variables, therefore, they can be better monitored. Artificial ageing is more reproducible than natural weathering. Thus, comparisons between different products are easier possible.
Calibration	Yes. Traceable reference standards are available.

INFRARED (IR) LABORATORY

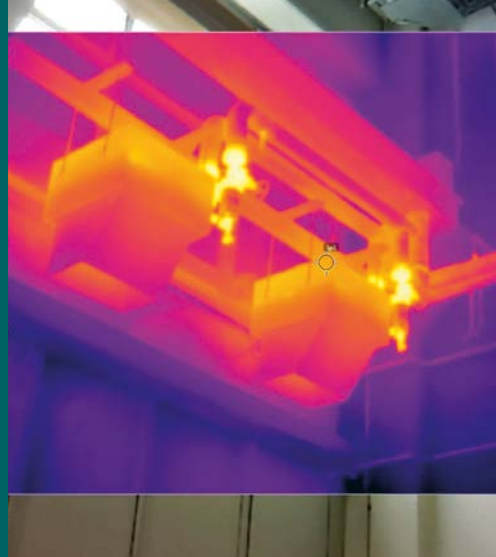

Measurement	Thermal radiation, temperatures, temperature distributions by thermography
Standards	DIN EN 13187, DIN 54190, ISO 18434-1
Measurement object	Technical building equipment, fireplaces, exhaust systems, façades and roof structures, thermal bridging, moisture retention, location of supply lines under plaster, vehicles, temperature analysis of larger surfaces and components, visualization of transient temperature behavior

TECHNICAL DATA OF INDIVIDUAL DETECTORS

Thermographic camera	Spectral range	7.8 to 14 μm
	Temperature range	-40 to +2000 °C, resolution 0.04 K
	IR image	frequency 30 Hz, 640 × 480 pixel
	Lenses	wide-angle 45°, 1.23 mrad
	Integrated digital camera, continuous superposition possible	
IR-video camera	Spectral range	7.5 to 13 μm
	Temperature range	-20 to +900°C, resolution 0.1 K
	IR image	frequency 100 Hz, 120 × 160 pixel
	Lenses	standard, wide-angle, telephoto
IR temperature sensors (special applications)	Spectral range	a) 2.3 μm b) 8 to 14 μm
	Temperature range	a) +50 to +400°C, resolution 0.2 K b) -40 to +900°C, resolution 0.1 K

SPECIAL FEATURES

Emissivity	Adjustable (afterwards) 0.1 to 1.0
Formats (camera dependent)	In addition to radiometric images also fully radiometric video can be created. There will also be saved all temperature information.
Recording	Trigger and timed recordings are possible.
Calibration	A precision Infrared Calibrator for the temperature range +35 to +500° C, emissivity = 0.95 is available as a reference standard.

WATER VAPOR TRANSMISSION PROPERTIES



Measurement	Water vapor resistance factor, diffusion equivalent air layer thickness
Standards	DIN EN ISO 12572, DIN EN 12086, DIN EN ISO 7783-2, DIN 1931, DIN 53122-1, ASTM E 96-95
Measurement object	Mineral materials like brick, lime stone, sandstone, concrete, plasters and renders, insulation materials, flexible sheets for waterproofing, roof underlays, etc.

TECHNICAL DATA

Sample size, circular	Diameter 90 mm, 100 mm, 200 mm
Sample size, rectangular (L × W)	100 × 100 mm 200 × 100 mm 180 × 130 mm Special dimensions possible
Test condition	Dry cup: +23 °C, 0 to 50 % r.h. Wet cup: +23 °C, 50 to 93 % r.h. Special conditions available

SPECIAL FEATURES

Accredited by DAkkS D-PL-11140-11-02	The laboratory has a flexible accreditation according to DIN EN ISO/IEC 17025 Test laboratory moisture, mortar, radiation, emissions
	Test reports can be issued

MORE INFORMATION

The water vapor transmission of building materials is one of the most important characteristics to estimate moisture behavior of constructions. In particular prevention of condensation and the drying of constructions are controlled by the water vapor transmission properties.

WATER ABSORPTION



Measurement	Capillary water absorption, a-value
Standards	DIN EN ISO 15148, DIN EN 1015-18, DIN EN 12087
Measurement object	Mineral materials like brick, lime stone, sandstone, concrete, plasters and renders, insulation materials, coatings, etc.

TECHNICAL DATA

Sample size, circular	Diameter 90 mm, 100 mm, 200 mm
Sample size, rectangular (L × W)	100 × 100 mm 200 × 100 mm 180 × 130 mm
Sample size, prism (L × W × H)	40 × 40 × 40 mm
	Irregular surface areas are possible as well, minimum area 50 cm ²

SPECIAL FEATURES

Accredited by DAkkS D-PL-11140-11-02	The laboratory has a flexible accreditation according to DIN EN ISO/IEC 17025 Test laboratory moisture, mortar, radiation, emissions
	Test reports can be issued.

MORE INFORMATION

- The water absorption coefficient is used to evaluate the capillary water uptake of building materials and an important data to estimate moisture protection of constructions.
- With the knowledge of the water absorption coefficient the calculation of the capillary transport coefficients for the water uptake is possible. These coefficients are used in simulations with WUFI®.

MOISTURE STORAGE, SORPTION



Measurement	Water content in % by volume, % by weight
Standard	DIN EN ISO 12571
Measurement object	Brick, lime stone, sandstone, concrete, plasters and renders, insulation materials, wooden materials, etc.

TECHNICAL DATA

Sample size	Any shape (bigger samples need more time to reach equilibrium)
Test conditions at +23 °C	50 % r.h. 65 % r.h. 80 % r.h. 93 % r.h. 97 % r.h. further conditions possible
Test method	Adsorption curve: equilibrium with increasing moisture content Desorption curve: equilibrium with decreasing moisture content

SPECIAL FEATURES

Accredited by DAkkS D-PL-11140-11-02	The laboratory has a flexible accreditation according to DIN EN ISO/IEC 17025 Test laboratory moisture, mortar, radiation, emissions
	Test reports can be issued

MORE INFORMATION

- Sorption of moisture means the exchange of water vapor between a material and the surrounding air until an equilibrium is reached.
- The sorption isotherm is used to determine the moisture storage function for a material specific WUFI® data set.

DRYING CURVE, DRYING OUT

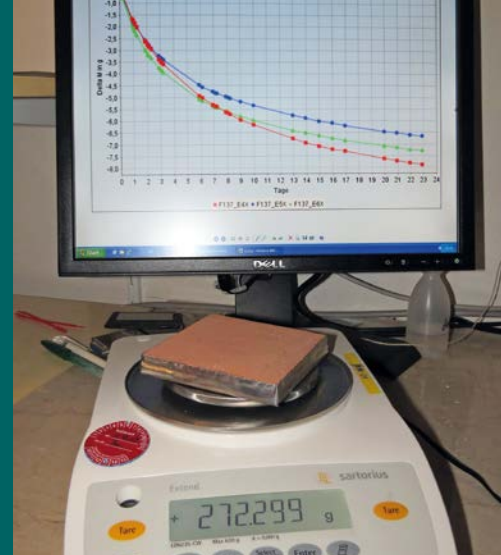

Measurement	Mass change per time unit
Standard	Own testing method
Measurement object	Brick, lime stone, sandstone, concrete, plasters and renders, insulation materials, wooden materials, etc.

TECHNICAL DATA

Sample size, circular	Diameter 100 mm, 200 mm
Sample size, rectangular (L x W)	100 x 100 mm 200 x 100 mm
Basic conditions	Climate chamber +23 °C, 50 % r.h.

SPECIAL FEATURES

Accredited by DAkkS D-PL-11140-11-02	The laboratory has a flexible accreditation according to DIN EN ISO/IEC 17025 Test laboratory moisture, mortar, radiation, emissions
	Test report can be issued

MORE INFORMATION

- A test specimen is saturated with water by immersion in water. The saturated specimen is sealed on the sides with aluminium foil and if necessary insulated. Then the drying out over the top face is measured in the climate chamber at +23 °C and 50 % r.h. The measured drying curve can be divided in a first drying period, which only relates to the test conditions (temperature, moisture, air velocity) and a second period, which is material dependent.
- Simple method for determination of the transport coefficients for the drying to be used in WUFI® material data set.

POROSITY, TRUE DENSITY



Measurement	Pore volume
Standard	DIN EN 1936
Measurement object	Porous materials like brick, lime stone, sandstone, concrete, plasters and renders, insulation materials, etc.

TECHNICAL DATA

Sample size	Max. 1 cm ³
Apparatus	Helium pycnometer AccuPyc II 1340 from Micromeritics

SPECIAL FEATURES

Accredited by DAkkS D-PL-11140-11-02	The laboratory has a flexible accreditation according to DIN EN ISO/IEC 17025 Test laboratory moisture, mortar, radiation, emissions
	Test report can be issued

MORE INFORMATION

- The true density of a material is defined as the mass of the dry material related to the volume of the solid matrix, which means minus the free accessible pore volume. The pore volume of the material sample is measured the helium pycnometer. Helium is an inert gas and has a very small diameter, though all accessible pores of the material can be reached.
- The porosity of a material can be calculated by knowing the bulk and true density.

MOISTURE DISTRIBUTION, NMR



Measurement	Moisture distribution, moisture profile, penetration depth
Measurement object	Building materials, drilling core, insulation materials, etc.

TECHNICAL DATA

Sample size	Prisms with a max. width of 50 mm Drilling cores with a max. diameter of 50 mm
Apparatus	NMR spectroscopy

SPECIAL FEATURES

Accredited by DAkkS D-PL-11140-11-02	The laboratory has a flexible accreditation according to DIN EN ISO/IEC 17025 Test laboratory moisture, mortar, radiation, emissions
	Test reports can be issued

MORE INFORMATION

- The contribution of weakly bounded protons in a material can be determined with this method. Therefore the moisture distribution at a certain time in materials or a combination of materials can be determined. Also the changes of the profiles, e.g., during a water uptake experiment or during a drying experiment, can be determined.
- The procedure can be used to determine the penetration depth of hydrophobic agents, impregnations or stone strengthening agents.

CAPILLARY ACTIVITY OF INTERIOR INSULATION MATERIALS



Measurement	Moisture content, moisture distribution
Standard	Own testing method
Measurement object	Insulation materials, etc.

TECHNICAL DATA

Sample size	Prisms with a max. width of 50 mm Drilling cores with a max. diameter of 50 mm
Apparatus	NMR spectroscopy
Equipment	Special experimental setup in the climate chamber

SPECIAL FEATURES

Accredited by DAkkS D-PL-11140-11-02	The laboratory has a flexible accreditation according to DIN EN ISO/IEC 17025 Test laboratory moisture, mortar, radiation, emissions
	Test reports can be issued

MORE INFORMATION

A sample of the insulation material with the dimensions 45 × 45 mm × material thickness is laterally sealed with an epoxy resin. The back side of the specimen is attached to a cooling device to manage a dew-point undercut. The front side is exposed to the climatic conditions in the climate chamber with +23 °C and 65 % r.h. This produces a gradient of temperature and partial pressure, and consequently vapor diffusion into the material. The adsorbed moisture is condensing at the sealed back side of the material, where it causes an increase of relative humidity; hence, the moisture content inside the material sample is rising. Due to the increasing gradient of relative humidity, a liquid transport back to the front of the material sets in. Eventually, the opposing moisture fluxes will reach a dynamic equilibrium. To reveal the hygrothermal behavior of the material samples during testing, two modes of measuring are taken. Through periodic gravimetric measurements, the moisture gain is analyzed and documented for the test period. The moisture distribution in the sample's cross-section is measured periodically by using nuclear magnetic resonance spectroscopy (NMR). The test results are reproduced by numerical simulation to determine and adapt the transport coefficients.

TENSILE STRENGTH, E-MODULUS



Measurement	Force and elongation, e-modulus
Standards	DIN EN ISO 8339 (sealing material), DIN EN 12311 (elastomer film), DIN 53457 (plastics), EN 1607 (insulation materials)
Measurement object	Sealing materials, elastomer films, fibrous insulation materials

TECHNICAL DATA

Sample size	Variable, depending on material
Apparatus	Zwick universal testing machine
	2 measuring ranges: up to 2 kN and up to 20 kN

SPECIAL FEATURES

Accredited by DAkkS D-PL-11140-11-02	The laboratory has a flexible accreditation according to DIN EN ISO/IEC 17025 Test laboratory moisture, mortar, radiation, emissions
	Test reports can be issued

MORE INFORMATION

- The stress-strain curve of different materials can be determined
- Durability and lifetime test of mechanical material properties after outdoor or artificial weathering

AIR-CONDITIONED TEST HALL



Measurement	Total water content, driving rain load
Standard	Own testing method
Measurement object	Wall elements in air-conditioned test hall exposed at the exterior to natural climate conditions

TECHNICAL DATA

Sample size	Wooden frame 50 × 50 cm, width: 20 cm or 40 cm
Field investigation	Wall with different composition
	Outdoor climate exposure to the west or east

SPECIAL FEATURES

Accredited by DAkkS D-PL-11140-11-02	The laboratory has a flexible accreditation according to DIN EN ISO/IEC 17025 Test laboratory moisture, mortar, radiation, emissions
	Test reports can be issued
	The wall elements can be removed from the test hall façade with a fork lift and weighed. Changes in weight of the wall elements can be determined, which are in correlation with the total water content.

MORE INFORMATION

Determination of moisture absorption or release to small-format wall elements, which are exposed to a controlled interior climate in the winter and to natural weathering on the outside. This method is meant to compare for example different external coatings or insulation systems. Moisture content, temperature profiles and heat fluxes can be measured.

DURABILITY WITH DRIVING RAIN IMPACT



Measurement	Weathering, field experiments, durability
Measurement object	Whole wall segments on a building facing towards east or west

TECHNICAL DATA

Sample size	Individual wall segments have a width of 1.20 m and height of 2.80 m
Field test	Installation of a wall construction in a test building
	Orientation to east and/or west
Measured variables	Weathering of fibrous insulation materials under natural conditions by: Determination of pull-off strength Determination of dirt collection Dilatation tests Protection against driving rain

SPECIAL FEATURES

Accredited by DAkkS D-PL-11140-11-02	The laboratory has a flexible accreditation according to DIN EN ISO/IEC 17025 Test laboratory moisture, mortar, radiation, emissions
	Test report can be issued

MORE INFORMATION

At a test building on the test field whole wall segments can be torn down and reconstructed. The building is air-conditioned in winter to an indoor climate of +20°C and 50 % r.h. Test duration is at least a period of 6 month up to several years. Temperature and moisture measurements on the wall sequence can be used for validation of WUFI® simulations.

DETERMINATION OF DEW WATER ON THE SURFACE

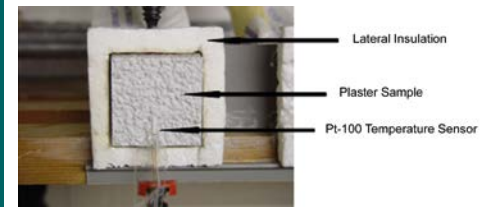

Measurement	Determination of dew water on the surface of exterior finishes caused by nocturnal long-wave radiation
Standard	Own testing method
Measurement object	Outside coatings like plaster or paint

TECHNICAL DATA

Sample size (H × W)	50 × 50 mm
Indoor climate	+20 °C, 65 % r.h.
Dew-point temperature undercut	Typically 1.5 K

SPECIAL FEATURES

- Determination of dew water on the surface by dabbing and weighing
- Dew-point temperature corresponding to the situation of outer walls in clear nights

MORE INFORMATION

- Course of the surface water during a condensation period of several hours is decisive for the risk of microbial manifestation
- Typical testing time: 2 to 8 hours (without preparation)

ACCELERATED TEST TO ASSESS THE MICROBIAL GROWTH RESISTANCE OF EXTERIOR FINISHES



Measurement	Sensitivity of coatings to microbial infestation
Standard	Own testing method
Measurement object	Outside coatings like plaster or paint

TECHNICAL DATA

Specimen size (H × W)	Typically 100 × 100 mm
Room volume	Approx. 2 m ³
Entrance door (H × W)	1.60 × 1.40 m
Number of specimen	Max. 70 (at 100 × 100 mm)

SPECIAL FEATURES

- Acceleration of microbial growth with a factor of 10 or more
- Natural transient climatic conditions in a daily course
- Autumn climate with weekly rain
- Simulation of the nocturnal undercooling by backside cooling below dew-point temperature
- Inoculation with a cocktail of microbial primary coloniser

MORE INFORMATION

- Left and right side separate individual undercooling possible
- Typical test time: 100 days

FLEXIBLE TEST FACILITY FOR FLAT AND PITCHED ROOF



Measurement object	Pitched roof constructions with between and top rafter insulation or combinations: solutions for gableboard or eaves, solar systems
---------------------------	---

TECHNICAL DATA

Ground area	42 m ²
Number of test rooms	4 test rooms, thereof 2 northern-oriented and 2 southern-oriented
Room volume/Floor area	Per test room 6 m ³ room volume with 7.45 m ² floor area
Net test area (L × W)	Pitched roof areas: each 2.5 × 2.5 m Fixed flat roof: 4.0 × 5.5 m

SPECIAL FEATURES

Flexible slope of the roof	Adjustable between 22 and 50° with steps of 1° without replacing the roof construction
HVAC	Heating and ventilation system for floor and room heating, local humidification to enable daily moisture load profiles
Measurement equipment	Networked data logging, optionally external access, basic metrological equipment; upgrading depending on requirements possible using existing subdistribution panels

MORE INFORMATION

Backfitting of a cooling system prepared

ACOUSTICS

Prof. Dr.-Ing. Philip Leistner
Head of Department
Phone +49 711 970-3346
Fax +49 711 970-3406
philip.leistner@ibp.fraunhofer.de

BUILDING CHEMISTRY, BUILDING BIOLOGY, HYGIENE

Dr. rer. nat. Florian Mayer
Head of Department
Phone +49 8024 643-238
Fax +49 8024 643-366
florian.mayer@ibp.fraunhofer.de

ENERGY SYSTEMS

Tekn. Dr. Dietrich Schmidt
Head of Department
Phone +49 561 804-1871
Fax +49 561 804-3187
dietrich.schmidt@
ibp.fraunhofer.de

HEAT TECHNOLOGY

Dipl.-Ing. Hans Erhorn
Head of Department
Phone +49 711 970-3380
Fax +49 711 970-3399
hans.erhorn@ibp.fraunhofer.de

HYGROTHERMICS

Dr.-Ing. Hartwig Künzel
Head of Department
Phone +49 8024 643-245
Fax +49 8024 643-366
hartwig.kuenzel@
ibp.fraunhofer.de

INDOOR CLIMATE

Dr.-Ing. Gunnar Grün
Head of Department
Phone +49 8024 643-228
Fax +49 8024 643-366
gunnar.gruen@ibp.fraunhofer.de

LIFE CYCLE ENGINEERING

Dipl.-Ing. Matthias Fischer
Head of Department
Phone +49 711 970-3155
Fax +49 711 970-3190
matthias.fischer@
ibp.fraunhofer.de

INSTITUTE STUTTGART

P.O. Box 80 04 69
70504 Stuttgart, Germany
Nobelstrasse 12
70569 Stuttgart, Germany
Phone +49 711 970-00
Fax +49 711 970-3395
info@ibp.fraunhofer.de

© Fraunhofer IBP 2015

HOLZKIRCHEN BRANCH

P.O. Box 11 52
83601 Holzkirchen, Germany
Fraunhoferstrasse 10
83626 Valley, Germany
Phone +49 8024 643-0
Fax +49 8024 643-366

KASSEL BRANCH

Gottschalkstrasse 28a
34127 Kassel, Germany
Phone +49 561 804-1870
Fax +49 561 804-3187

NÜRNBERG BRANCH

c/o Energie Campus
Nürnberg
Fürther Strasse 250
Auf AEG, Bau 16
90429 Nürnberg, Germany
Phone +49 911 56854-9144

ROSENHEIM BRANCH

Fraunhofer Center Building
Technology
c/o Hochschule Rosenheim
Hochschulstrasse 1
83024 Rosenheim, Germany
Phone +49 8031 805-2684